



PRODUCT RANGE

PRECISION MEASURING INSTRUMENTS

10/2018

SCHWENK
LÄNGENMESSTECHNIK
GMBH & CO. KG



Pictographs

LEGEND TO SYMBOLS

	Through bores 6-11, 14, 18-20, 22-24		Thickness / distance 14		Medium diameter 16
	Deep bores 7, 10, 22-24		Internal key seating 22-24		Minor diameter of internal threads 17-20, 22-24
	Short bores 6-9, 12, 13, 14, 18-20, 22-24		Shaft grooves 22-24		Major internal diameter of a ball screw 11, 12
	Blind bores 9, 12, 13, 18-20, 22-24		Parallel distances 11, 18-20, 22-24		Wall indentations in a bore 22-24
	Internal multi-splines 11		Bore depth 14		Penetrating bores 6-10, 14, 22-24
	Internal gears 11		Internal taper length 14		Outside diameter 26, 27
	Bores in easily deformable materials 16-20		Inside chamfer 14, 28		
	Pillow blocks 12-14		Outside chamfer on inquiry		
	Internal grooves 12-14		Roundness 6-10, 12, 14, 18-20, 22-24, 26		
	Internal grooves / special 12-14		Cylindricity 6-10, 14, 18-20, 22-24		
	Undercuts 12, 13		Straightness of a bore on inquiry		
	Outside diameter of a recessed section in a bore 26		Concentricity on inquiry		
	Inside diameter bore, having a centre obstruction 26		Coaxiality on inquiry		
	Bores with central hub 26		Position of bores on inquiry		
	Bores with axial obstruction 18-20, 22-24, 26		Centre distance on inquiry		
	Interrupted bores 18-20, 22-24		Axial run-out on inquiry		
	Spherical bores 6-8, 12, 13, 18-20		Internal taper 22-24		
	Thread distance / groove width 14		Shallow bores 18-20, 22-24		
			Spigot 25		

Circometer®
(Reg.-No.: 429 851)

mytast®
(Reg.-No.: 702 254)

OSIMESS®
(Reg.-No.: 798 203)
are registered brand names
of SCHWENK Beteiligungs-
GmbH & Co. KG.

SUBITO®
(Reg.-No.: 508 662)
is a registered
trademark of Hahn + Kolb
Werkzeuge GmbH.

Content

PRECISION MEASURING INSTRUMENTS

SERIES	DESCRIPTION	MODEL	PAGE
100-118	SUBITO® standard design	SU/SK/SW	6-7
120	Measuring depth extensions for SUBITO®	MTV	7
122-124	SUBITO® Vario/SUBITO® Vario System	SV/SVS	8
404-416	RABITO for internal diameters	RA	9
140-146	SUBITO® for blind bores	SS/SSV	9
230-244	SUBITO® in special measuring depth	SMT	10
130-133	SUBITO® for deep bores	SE	10
160-164	SUBITO® for internal toothings	KT	11
	Splined plug gauges		11
165-167	SUBITO® for grooves and recesses	SN	12
170-176	SUBITO® for grooves and recesses/pillow blocks	ST	12
190	Gauges for internal grooves and recesses	ON/ONM	12-13
	Internal grooves gauges	ON-OD	14
198-199	Distance measuring gauges	OT	14
121	CITO 3P	CI	14
125	Setting device for 2-point internal measuring gauges	ESU	15
620 - 621	Circometer® Measuring tapes for outside circumference and diameter	CJU/C	16
	Precision steel rulers		16
622	Measuring tapes for plane-parallel distances	CJL	17
623	Measuring tapes for inside circumference	IUB	17
624	Novometer	NO	17
625-628	OSIMESS® bore gauges	OS/OSH/OSS	18
	OSIMESS® measuring needles		19
	OSIMESS® spare parts		19-20
625-628	OSIMESS® special probes	OSF	20
629	OSIMESS® measuring stands	OSM 5/OSM 6	21
129	Setting rings		21
300-326	OD Plug gauges for bores	OD	22-24
	OD Plug gauges accessories		25
155	Bore gauges for bores with a hub	SBO/SBU	26
150-154	SUBITO® for bores with a boring bar	SL	26
150-154	Measuring gauges for outside diameters	SLA	26
155	Ring gauge for outside diameter	MRD	27
	SUBITO® with direct measuring axis	SD	27
	Measuring gauges for internal threads	OSG, ONG, SNG	27
194	Internal chamfer gauge	IFM	28
	Chamfer length measuring gauge	FLM	28
610-611	Precision indicators according to DIN 879		29
600	Dial gauges according to DIN 878		29
613	Digital dial gauges		29
680	Tungsten carbide precision balls		30
680	Ruby, ceramic precision balls		30-31
681	Special measuring inserts		31
614	Linear stroke ball bearing		31
650	Measuring instrument test device	MPV	32
699	Manufacturer calibration report		32-33





Precision meets passion
Why we are the source of inspiration for bore measuring

Since 2014 the name SCHWENK Längenmesstechnik GmbH & Co KG stands for the design and production of high-quality precision measuring instruments. The company SCHWENK Längenmesstechnik GmbH & Co KG has its origin in the company OSKAR SCHWENK GmbH & Co. KG - one of the oldest manufacturers of precision measuring instruments in the global market.

Back in 1921 the company's founder Oskar Schwenk patented the internationally known bore gauge SUBITO. The „SUBITO“ has become a synonym for all measuring instruments of this type and still set the benchmark for quality, precision and service life. Until today tradition und innovation are inherent parts of our company philosophy – for a long time the brand SCHWENK is a source of inspiration for bore measuring. Should our comprehensive standard program prove insufficient for solving your particular measuring tasks, we can produce individual solutions for you: from modified hand-held measuring instruments over manually operated measuring devices up to fully automatic versions, which are integrated in the production cell.

You ensure your quality with our measuring instruments. It goes without saying that our own products are subject to the highest quality demands. It is guaranteed by the qualification and expert knowledge of our staff and our in-house quality control process.

We know why customer satisfaction is so important and with the conception and the design of our products we set a high value on them being service friendly and easy to maintain. Even many spare and wear mechanical parts are available for a period of many years. If a measuring instrument should fail calibration requirements after years of use, our repair and calibration department takes care of this. It can resort to our well-sorted spare parts stock and ensure a fast and easy processing and adjustment of your measuring instrument.

SUBITO® Precision Bore Gauge SU/SK/SW

FOR MEASURING INTERNAL DIAMETERS,
APPLICATION RANGE 4,5 - 800 MM

SERIES 100-118

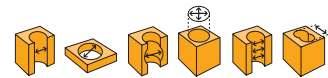

STANDARD VERSION SERIES SU with manufacturer certificate

Delivery SU:

holder, fixed measuring pins, washers, in case, without dial gauge. Movable contact pin as standard tungsten carbide.

Ruby Version SU: Measuring pins and contact pin ruby.

Version centring plate coated wear resisting: standard with measuring pins tungsten carbide.

SHORT VERSION SERIES SK with manufacturer certificate

Delivery SK:

as Series SU, but with a short holder.

ANGLED VERSION SERIES SW

Delivery SW:

as Series SU, but holder with a fixed angle piece.



SUBITO® SU 50 - 100

SUBITO® SU/SK/SW

application range [mm]	measuring pins steel			measuring pins tungsten carbide			centring plate coated	
	SU	Code SK	SW	SU	Code SK	SW	SU	Code SK
4,5 - 6	-	-	-	100 00000	100 00001	200 00000	-	-
6 - 8	-	-	-	101 00000	101 00001	201 00000	101 00004	101 00005
8 - 12	-	-	-	102 00000	102 00001	202 00000	102 00004	102 00005
12 - 20	-	-	-	103 00000	103 00001	203 00000	103 00004	103 00005
18 - 35	104 00000	104 00001	204 00000	104 00002	104 00003	204 00001	104 00006	104 00007
35 - 60	105 00000	105 00001	205 00000	105 00002	105 00003	205 00001	105 00006	105 00007
50 - 100	106 00000	106 00001	206 00000	106 00002	106 00003	206 00001	106 00006	106 00007
50 - 150	107 00000	107 00001	207 00000	107 00002	107 00003	207 00001	107 00006	107 00007
100 - 160	108 00000	108 00001	208 00000	108 00002	108 00003	208 00001	108 00006	108 00007
100 - 230	109 00000	109 00001	209 00000	109 00002	109 00003	209 00001	109 00006	109 00007
160 - 290	110 00000	110 00001	210 00000	110 00002	110 00003	210 00001	110 00006	110 00007
160 - 360	111 00000	111 00001	211 00000	111 00002	111 00003	211 00001	111 00006	111 00007
280 - 410	112 00000	112 00001	212 00000	112 00002	112 00003	212 00001	112 00006	112 00007
280 - 510	113 00000	113 00001	213 00000	113 00002	113 00003	213 00001	113 00006	113 00007
400 - 800	114 00000	114 00001	214 00000	114 00002	114 00003	214 00001	114 00076	114 00077

SUBITO® with extended measuring range, for spherical diameters, for diameters > 800 mm and for parallel distances on inquiry. SUBITO® direct SD please see page 27.

COMBINATION OF

SEVERAL COMPLETE SETS with manufacturer certificate

to cover large measuring ranges, consisting of 2 and 3 complete measuring instruments in one case, without dial gauge.

SUBITO® SU

application range [mm]	measuring pin steel Code	measuring pin carbide Code	centring plate coated Code	measuring pin ruby Code
18 - 100	115 00000	115 00002	115 00006	115 00004
18 - 150	116 00000	116 00002	116 00006	116 00004
50 - 160	117 00000	117 00002	117 00006	117 00004
50 - 230	118 00000	118 00002	118 00006	118 00004



SUBITO® several complete sets



SUBITO® SW



SUBITO® holder



SUBITO® SU 4,5 - 6 and SU 35 - 60

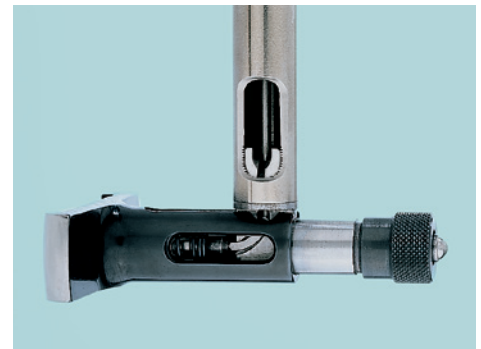

SUBITO® segment

SW	measuring pins ruby Code SK			holder Code SK		
	SU	SW	SK	SU	SK	
-	-	-	-	100 00049	100 00050	
201 00002	101 00002	101 00003	201 00001	101 00045	101 00046	
202 00002	102 00002	102 00003	202 00001	102 00046	102 00047	
203 00002	103 00002	103 00003	203 00001	103 00055	103 00056	
204 00003	104 00004	104 00005	204 00002	104 00067	104 00068	
205 00003	105 00004	105 00005	205 00002	105 00062	105 00063	
206 00003	106 00004	106 00005	206 00002	106 00077	106 00078	
207 00003	107 00004	107 00005	207 00002	106 00077	106 00078	
208 00003	108 00004	108 00005	208 00002	108 00064	108 00065	
209 00003	109 00004	109 00005	209 00002	108 00064	108 00065	
210 00003	110 00004	110 00005	210 00002	110 00044	110 00045	
211 00003	111 00004	111 00005	211 00002	110 00044	110 00045	
212 00003	112 00004	112 00005	212 00002	112 00068	112 00069	
213 00003	113 00004	113 00005	213 00002	112 00068	112 00069	
214 00003	114 00004	114 00005	214 00002	114 00140	114 00141	

Measuring depth extension **MTV**

FOR SUBITO® BORE GAUGES, PLUG-IN EXTENSION,
CLAMPING SHANK Ø 8 MM

suitable from diameter 35 mm

MEASURING DEPTH EXTENSION MTV

tube-Ø [mm]	length [mm]	Code	tube-Ø [mm]	length [mm]	Code
12	250	120 00000	18	1000	120 00004
12	500	120 00001	18	1500	120 00005
12	750	120 00002	18	2000	120 00006
12	1000	120 00003	special length		on inquiry

Measuring depth extensions with CFK tube on inquiry.

SERIES 120



measuring depth extension MTV

SUBITO® Vario Precision Bore Gauge SV/SVS

SERIES 122-124

FOR MEASURING INTERNAL DIAMETERS,
APPLICATION RANGE 6 - 800 MM

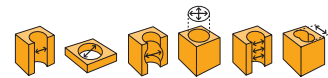

Delivery SV:

SUBITO® Vario SV modular system consisting of one upper part and different measuring heads in Vario design; with fixed measuring pins, washers, in case, without dial gauge.

SUBITO® VARIO SV/SVS

application range [mm]		measuring pin steel Code	measuring pin carbide Code
type SV	measuring heads SUBITO® Vario		
6 - 18	6 - 10	-	122 00000
	10 - 18	-	-
6 - 10	6 - 10	-	122 00001
	10 - 18	-	122 00002
18 - 160	18 - 50	123 00000	123 00008
	50 - 160	-	-
18 - 50	18 - 50	123 00001	123 00009
	50 - 160	123 00002	123 00010
160 - 800	160 - 430	124 00000	124 00004
	430 - 800	-	-
160 - 430	160 - 430	124 00001	124 00005
	400 - 800	124 00002	124 00006



SUBITO® Vario SV

Delivery SVS:

as series SV, but with a short upper part and additional blind bores measuring head and measuring slides, an angle piece 90° to reach awkwardly positioned bores and a measure depth extension 192 mm; in case, without dial gauge.

SUBITO® VARIO SVS

application range [mm]		measuring pin steel Code	meas. pin carbide Code
type SVS	measuring heads		
18 - 160	SUBITO® Vario 18 - 50	-	-
	SUBITO® Vario 50 - 160	-	-
18 - 160	blind bores 20 - 50	123 00005	123 00013
	blind bores 50 - 140	-	-



SUBITO® Vario System SVS

ACCESSORIES SV/SVS

application range [mm]	Code
6-18 mm	
screw-in depth extension 250 mm long, tube-Ø 5 mm	122 00005
18-160 mm	
screw-in depth extension 192 mm long, tube-Ø 10 mm	123 00007
screw-in depth extension 500 mm long, tube-Ø 10 mm	123 00033
screw-in depth extension 750 mm long, tube-Ø 10 mm	123 00034
screw-in depth extension 1000 mm long, tube-Ø 10 mm	123 00035
160-800 mm	
screw-in depth extension 485 mm long, tube-Ø 24 mm	124 00003
screw-in depth extension 1000 mm long, tube-Ø 24 mm	124 00007
screw-in depth extension CFK 1000 mm long, tube-Ø 24 mm	123 00601
screw-in depth extension CFK 1500 mm long, tube-Ø 24 mm	123 00603
screw-in depth extension CFK 2000 mm long, tube-Ø 24 mm	123 00605

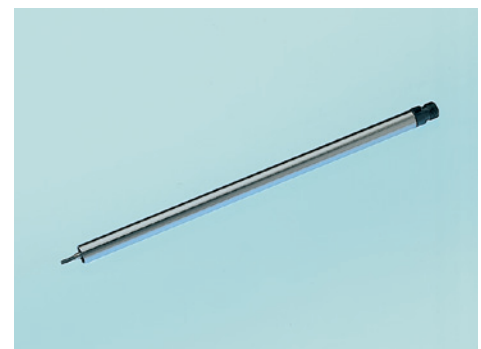

screw-in depth extension 250 mm long, tube Ø 5 mm

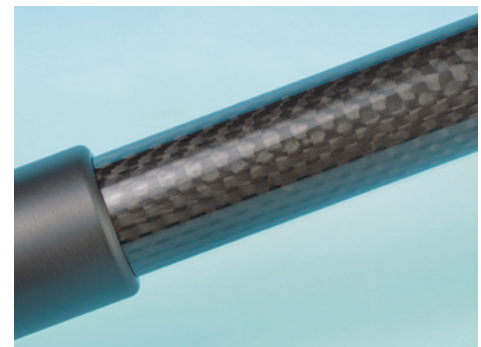

screw-in measuring depth extension CFK, 1000 mm long, tube Ø 24 mm

RABITO Precision Bore Gauge ^{RA}

FOR MEASURING INTERNAL DIAMETERS,
APPLICATION RANGE 18 - 300 MM

Delivery RA:

holder, fixed measuring pins in steel, washers, in case, without dial gauge.

RABITO RA

application range [mm]	Code
18 - 35	404 00001
35 - 60	405 00001
50 - 150	407 00001
18 - 150*	416 00001
150 - 300	410 00001

* consists of 2 complete sets in case

SERIES 404-416

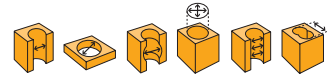

RABITO 50-150

SUBITO® Precision Bore Gauge ^{SS/SSV}

FOR MEASURING OF BLIND BORE DIAMETERS

Delivery SS:

holder, measuring slides and contact pin tungsten carbide as standard, in case, without dial gauge. Version with h = 1 mm: for measuring very close of the bottom of the bore.

SUBITO® SS

application range [mm]	front distance h [mm]	meas. slides carbide Code	meas. slides ruby Code	holder SS Code
20 - 50	1,5	140 00000	140 00001	140 00024
20 - 60	1,5	141 00000	141 00001	141 00024
50 - 110	1,5	142 00000	142 00001	142 00027
50 - 140	1,5	143 00000	143 00001	142 00027
110 - 300	2,0	144 00000	144 00001	144 00032
110 - 400	2,0	145 00000	145 00001	144 00032
300 - 600	2,0	145 00100	145 00101	145 00105
20 - 50	1,0	140 00002		
20 - 60	1,0	141 00002		
50 - 110	1,0	142 00002		
50 - 140	1,0	143 00002		
110 - 300	1,0	144 00002		
110 - 400	1,0	145 00002		
300 - 600	1,0	145 00102		

Delivery SSV:

1 short upper part, 2 blind bores measuring heads, measuring slides, in case, without dial gauge.

SUBITO® BLINDE BORES VARIO SSV

application range [mm]	front distance h [mm]	meas. slide carbide Code	meas. slide ruby Code
20 - 140	1,5	146 00000	146 00001
20 - 140	1,0	146 00002	

SERIES 140-146



SUBITO® SS for blind bores

s: travel

D: diameter to be measured

h: front distance

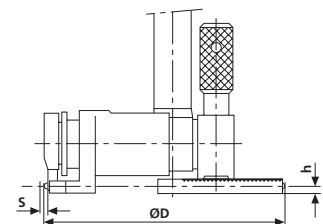

front distance h for SUBITO® SS

SUBITO® Precision Bore Gauge SMT

FOR MEASURING INTERNAL DIAMETERS
IN LARGE DEPTH

SERIES 230-244

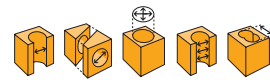

Delivery SMT:

as Series SU, but holder in special length; fixed measuring pins and movable contact pin tungsten carbide tipped as standard, coated centering plate, in case or transportation box, without dial gauge.
Larger and intermediate depth on inquiry.

SUBITO® SMT

application range [mm]	measuring depth [mm]			
	250 Code	500 Code	750 Code	1.000 Code
4,5 - 6	230 00000	-	-	-
6 - 8	231 00000	231 00001	231 00002	231 00003
8 - 12	232 00000	232 00001	232 00002	232 00003
12 - 20	233 00000	233 00001	233 00002	233 00003
18 - 35	234 00000	234 00001	234 00002	234 00003
35 - 60	235 00000	235 00001	235 00002	235 00003
50 - 100	236 00000	236 00001	236 00002	236 00003
50 - 150	237 00000	237 00001	237 00002	237 00003
100 - 160	-	238 00001	238 00002	238 00003
100 - 230	-	239 00001	239 00002	239 00003
160 - 290	-	240 00001	240 00002	240 00003
160 - 360	-	241 00001	241 00002	241 00003
280 - 410	-	242 00001	242 00002	242 00003
280 - 510	-	243 00001	243 00002	243 00003



SMT, SU, SK

application range [mm]	measuring depth [mm]				
	1.250 Code	1.500 Code	2.000 Code	2.500 Code	3.000 Code
18 - 35	234 00004	-	-	-	-
35 - 60	235 00004	235 00005	235 00006	235 00007	235 00008
50 - 100	236 00004	236 00005	236 00006	236 00007	236 00008
50 - 150	237 00004	237 00005	237 00006	237 00007	237 00008
100 - 160	238 00004	238 00005	238 00006	238 00007	238 00008
100 - 230	239 00004	239 00005	239 00006	239 00007	239 00008
160 - 290	240 00004	240 00005	240 00006	240 00007	240 00008
160 - 360	241 00004	241 00005	241 00006	241 00007	241 00008
280 - 410	242 00004	242 00005	242 00006	242 00007	242 00008
280 - 510	243 00004	243 00005	243 00006	243 00007	243 00008

SUBITO® Precision Bore Gauge SE

FOR MEASURING DEEP BORES

SERIES 130-133



For the use with an electronic length measuring probe and indicating unit; measuring depths up to 12 m are possible.
A complete instrument consists of: measuring head, connecting tube (1000 mm) with cardan joint, length measuring probe, extensions if necessary. Delivery in transportation box, without length measuring probe, without indicating unit.

SUBITO® SE

application range [mm]	Code
35 - 60	130 00000
50 - 90/(120)*	131 00000/01
100 - 230	132 00000
> 200	auf Anfrage

* measuring range extension up to Ø 120 mm/160 mm on request.



SUBITO® SE for deep bores
up to 12 m depth

SUBITO® Precision Bore Gauge **KT**

FOR MEASURING THE TWO-BALL DIMENSION OF TOOTHINGS

SERIES 160-164

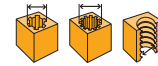

Delivery KT:

holder with contact pin and exchangeable measuring inserts; contact pin and measuring inserts with inside thread to screw in ball inserts; in case, ball inserts to be ordered separately. Measuring gauges for internal gears from diameter > 8 mm based on OSIMESS® on inquiry.

SUBITO® KT

application range M [mm]		Code
KT 12	8 - 12	160 0000
KT 22	12 - 22	161 0000
KT 55	22 - 55	162 0000
KT 250	55 - 250	163 0000
KT 510	100 - 510	164 0000



SUBITO® KT with measuring inserts and ball inserts

ACCESSORIES KT

application range M [mm]		thread	Code	
KT 12	1 set ball inserts with tungsten carbide balls of your choice*; ball-Ø d over 0,8 up to 2 mm (1 x measuring pin, 1 x ball insert)	M 1,6	160 00001	
	as above however with intermediate dimension		160 00101	
KT 22	1 set ball inserts with tungsten carbide balls of your choice*; ball-Ø d over 0,8 up to 4 mm	M 1,6	161 00001	
	as above however with intermediate dimension		161 00101	
KT 55	1 set ball inserts with tungsten carbide balls of your choice*; up to ball-Ø d 7 mm	M 2,5	162 00001	
	as above however with intermediate dimension		162 00101	
	1 set ball inserts with tungsten carbide balls of your choice*; ball-Ø d over 7 up to 10 mm		162 00003	
	as above however with intermediate dimension		162 00103	
	reducing socket for the use of ball inserts		M1,6/M2,5	162 00032
KT 250/510	KT 22 in KT 55			
	1 set ball inserts with tungsten carbide balls of your choice*; up to ball-Ø d 7 mm	M 4	163 00001	
	as above however with intermediate dimension		163 00101	
	1 set ball inserts with tungsten carbide balls of your choice*; ball-Ø d over 7 up to 10 mm		M4/M 2,5	163 00003
	as above however with intermediate dimension		163 00103	
reducing socket for the use of ball inserts	162 00004			
	KT 55 in KT 250/510			

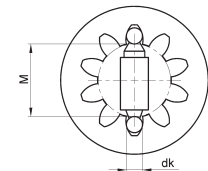

even number of teeth

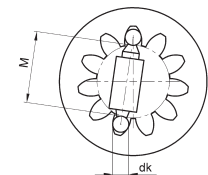

odd number of teeth

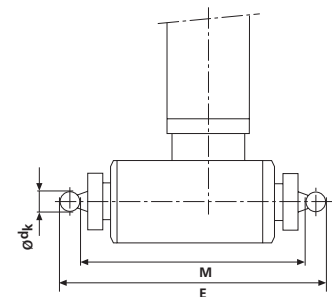

SUBITO® KT - dimensions

* Ball inserts with standard ball diameter < 10 mm according to our tungsten carbide ball list on page 30.

Ball inserts with tungsten carbide ball diameter < 0,8 mm and > 10 mm on inquiry.

Splined Plug Gauge

FOR MEASURING THE DIAMETRAL TWO-BALL DIMENSION IN THE RANGE M (DISTANCE BETWEEN BALLS) 12 - 100 MM - MEASURING WITHOUT TIPPING OF THE GAUGE.

- fully toothed design.
- plain design with positioning pin. on inquiry



Splined Plug Gauge

SUBITO® Precision Bore Gauge SN

FOR MEASURING GROOVES AND RECESSES

Holder with retraction for measuring recesses with groove width from 3 mm; in case, without dial gauge. Delivery with one measuring pin for the required diameter within the application range.

SUBITO® SN

application range [mm]	retraction [mm]	Code
60 - 120	8,5	165 00000
120 - 180	23	166 00000
180 - 300	30	167 00000

SERIES 165-167

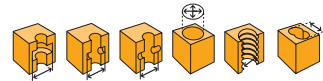

SUBITO® SN for grooves and recesses

SUBITO® Precision Bore Gauge ST

FOR MEASURING PILLOW BLOCK HOUSINGS, INTERNAL GROOVES AND RECESSES

with 180° rotatable fixed measuring pin; in case, without dial gauge.

SUBITO® ST

application range [mm]		standard measuring depth	meas. depth 200 [mm]	meas. depth 400 [mm]	meas. depth 750 [mm]
30 - 52	ST 52	170 00000	170 00001	170 00002	170 00003
50 - 70	ST 70	171 00000	171 00001	171 00002	171 00003
60 - 100	ST 100	172 00000	172 00001	172 00002	172 00003
80 - 150	ST 150	173 00000	173 00001	173 00002	173 00003
120 - 220	ST 220	174 00000	-	174 00002	174 00003
180 - 360	ST 360	175 00000	-	175 00002	175 00003
290 - 530	ST 530	176 00000	-	176 00002	176 00003

SERIES 170-176

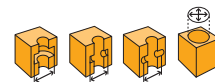

SUBITO® ST with fixed measuring pin turned in

Precision Bore Gauge ON/ONM

FOR MEASURING GROOVES AND RECESSES

Complete set consists of basic unit and expanding probe ON, ONM (additionally with measuring slides); retraction travel up to 10 mm (standard); up to 20 mm from Ø 40 mm possible; delivery in case, without expanding probe and dial gauge.

expanding probe ON: probe with determined range of application.

expanding probe ONM: probe with flexible range of application through movable slides, which have to be ordered separately.

BASIC UNIT ON/ONM

	Code
holder for expanding probe ON and ONM for Ø 6 - 55 mm	190 00000
from Ø 20 mm*	190 00042

* with stronger spring

SERIES 190

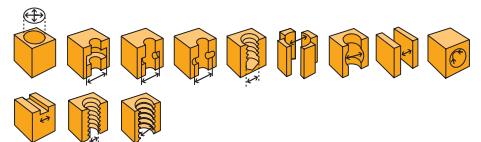

ON / ONM basic unit with expanding probe ON, ONM and measuring slides

Precision Bore Gauge **ON/ONM**

SERIES 190

FOR MEASURING GROOVES AND RECESSES

EXPANDING PROBE ON

application range [mm]	Code	blind bore design
6 - 8	190 00001	
8 - 12	190 00002	
10 - 14	190 00003	
12 - 18	190 00004	
16 - 22	190 00005	
special ranges	190 00035	

EXPANDING PROBE ONM

application range [mm]	travel [mm]	Code standard design	Code blind bore design
20 - 55	10	190 00006	190 00110
40 - 200	10	190 00013	190 00111
40 - 200	20	190 00041	190 00112

MEASURING SLIDES FOR ONM

for ONM 20-55 application range [mm]	Code	for ONM 20-55 application range [mm]	Code
20 - 30	190 00007	40 - 50	190 00011
25 - 35	190 00008	45 - 55	190 00012
30 - 40	190 00009	special range	190 00036
35 - 45	190 00010		

for ONM 40-200 application range [mm]	Code	for ONM 40-200 application range [mm]	Code
40 - 50	190 00014	70 - 80	190 00020
45 - 55	190 00015	75 - 85	190 00021
50 - 60	190 00016	80 - 90	190 00022
55 - 65	190 00017	85 - 95	190 00023
60 - 70	190 00018	90 - 100	190 00024
65 - 75	190 00019	95 - 105	190 00025

blind bore design - measuring slides surcharge	190 00900
special ranges from 40 - 100 mm	190 00038
special ranges from 100 - 200 mm	190 00039
> 100 up to maximum 200 mm in 5 mm steps	190 00037

ACCESSORIES / OPTIONS

	Code
measuring depth extension 100 mm from \varnothing 20 mm	190 00032
measuring depth extension 250 mm from \varnothing 20 mm	190 00033
depth stop	190 00034
expanding probe - hard chrome plated	190 00901
measuring slide - hard chrome plated	190 00902
adapting expanding probes / measuring slides to reduced groove width B	190 00900

version for grooves $\varnothing < 6$ mm on inquiry



ON/ONM Accessories measuring depth extension, depth stop

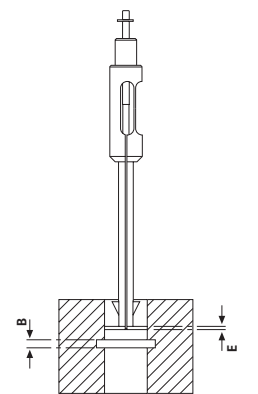

insertion

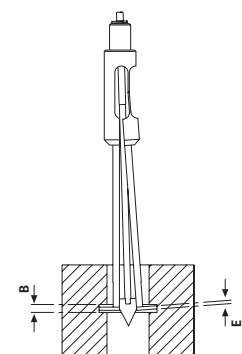

measurement

Groove Measuring Gauge ON-OD **ON-OD**

FOR THE SAFE AND FAST SERIES MEASURING OF GROOVES

Centring diameter of the measuring sleeve OD in the range 20 to 100 mm.
A split probe of the series ON/ONM is integrated in a measuring sleeve OD and ensures an automatic alignment and centring of the measuring axis.
Measuring without tipping of the gauge. Design individually for a specific measuring task; without dial gauge.

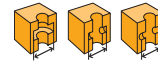

Groove Measuring Gauge ON-OD

Distance Measuring Gauges **OT**

FOR MEASURING BORE DEPTHS, SHOULDERS,
WIDTHS/DISTANCES OF GROOVES AND RECESSES

SERIES OT

	meas. depth [mm]	Code
OT - Standard with 6 mm ball insert M 2,5 and measuring bridge 80 mm, in case	175/325	198 00000/198 00002
OT 4 - complete set with handle, measuring sleeve and probe finger, in case	175/300	199 00000/199 00001

SERIES 198-199



OT Depth Measuring Gauge
OT 4 (top) and
OT - standard (bottom)

CITO 3P Precision Measuring Gauge **CI**

FOR MEASURING INTERNAL DIAMETERS

Delivery CI:

holder, measuring pins tungsten carbide, w/o dial gauge
Measuring w/o tipping, no need to search for reversal point on indicator.

CITO 3P

application range [mm]	Code
12 - 20	121 00005
20 - 35	121 00000
35 - 55	121 00001
50 - 80	121 00002
80 - 120	121 00003
120 - 170	121 00004

SERIES 121

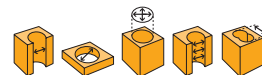

CITO 3P

SUBITO® Setting Device **ESU**

SERIES 125

FOR SETTING TWO-POINT COMPARATOR PRECISION BORE GAUGES WITH THE HELP OF GAUGE BLOCKS

Delivery ESU:

frame with setting jaws holder, pair of setting jaws, tungsten carbide measuring anvils in gauge block quality, clamping unit, in box; without gauge blocks

FOR SUBITO® SU/SK/SW/SMT/SP/SV

setting range [mm]	Code
4,5 - 35	125 0000
4,5 - 160	125 0001
4,5 - 290	125 00029
18 - 160	125 00028
18 - 290	125 00002
160 - 510	125 00003
160 - 800	125 00030
160 - 1.200	125 00043
160 - 1.500	125 00045
160 - 2.000	125 00046

models for bore gauges of other brands on inquiry

for series	setting range [mm]	Code
SS	20 - 300	125 00005
SS	20 - 600	125 00038
ST	30 - 220	125 00006
ST	180 - 530	125 00007
OD-K/OD-KK	130 - 300	125 00034
OD-K/OD-KK	130 - 500	125 00035

SPARE PARTS

setting range [mm]	Code
setting jaws holder with spreading lever (suitable for all setting jaw pairs, except SP)	125 00008
Pair of setting jaw with stay bolt and nut	
4,5 - 35	125 00009
18 - 290	125 00011
20 - 300	for SS 125 00012
30 - 220	for ST 125 00013
6 - 160	with setting jaw holder for SP 125 00014
prism pair for OD cross sleeve / cross sleeve with runners	125 00033
pair of tungsten carbide measuring anvils for ESU 4,5 - 300	125 00015
pair of tungsten carbide measuring anvils for ESU 160 - 800	125 00036
stand for vertical use for ESU 4,5-290	125 00018
stand for vertical use for ESU 160-800	125 10052



ESU Setting Device with vertical measuring axis

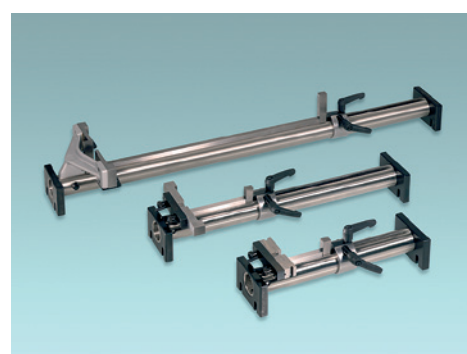

ESU Setting Device 510/290/160 with horizontal measuring axis



ESU accessories setting jaws/ measuring anvil

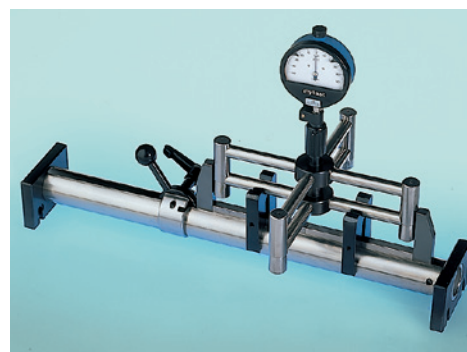

ESU Setting Device for OD cross sleeves/ cross sleeve with runners

Circometer® CJU/C

SERIES 620-621

MEASURING TAPES FOR MEASURING OUTSIDE CIRCUMFERENCE AND DIAMETER OF CYLINDRICAL PARTS



CIRCOMETER® CJU

Circumference tape for measuring the outside circumference and diameter; graduation distance 1 mm, scaling according to DIN 866; with vernier 0,1 mm, laserscaled. Tape width: 16 mm.



Circometer® CJU

CIRCOMETER® CJU

circumference range [mm]	diameter range [mm]	type	Code steel	Code stainless steel	Code black	stainless steel width 35 mm	
60 - 950	20 - 300	950	620 00001	620 00027	620 00200	620 00915	
940 - 2200	300 - 700	2200	620 00002	620 00028	620 00201	620 00918	
2190 - 3460	700 - 1100	3460	620 00003	620 00029	620 00202	620 00928	
3450 - 4720	1100 - 1500	4720	620 00004	620 00030	620 00203	620 00936	
4710 - 5980	1500 - 1900	5980	620 00005	620 00031	620 00204	620 00911	
5970 - 7230	1900 - 2300	7230	620 00006	620 00032	620 00205	620 00912	
7220 - 8500	2300 - 2700	8500	620 00007	620 00033	620 00206	620 00916	
8490 - 9760	2700 - 3100	9760	620 00008	620 00034	620 00207	620 00950	
9730 - 11010	3100 - 3500	11010	620 00009	620 00035	620 00208	620 00951	
- 23550	- 7500	on inquiry					

further band widths (6/60 mm), INCH design and with special reading 0,05 mm in diameter on inquiry

C-TAPE

C-measuring tape for determining the outside diameter; graduation distance 1 mm, with vernier 0,05 mm, laserscaled. Tape width: 12 mm. Standard design: out of stainless steel

Black coated design: for maximum reading contrast



top: C-tape black
C-tape with vernier 0,05

C-TAPE

measuring range [mm]	type	Code stainless steel	Code black
15 - 115	C 115	621 00063	621 00110
100 - 230	C 230	621 00064	621 00111
200 - 330	C 330	621 00065	621 00112
300 - 620	C 620	621 00073	621 00116



Precision steel rulers

FOR FAST AND ACCURATE LENGTH-MEASURING

Steel rulers are made of stainless steel. Wide design with double laser marked scaling, in mm. Mat surface for better reading. High precision, width 30 mm.

PRECISION STEEL RULERS

measuring range [mm]	deviation [mm]	Code
150	±0,1	620 00849
300	±0,1	620 00842
500	±0,1	620 00843
1000	±0,15	620 00844
2000	±0,2	620 00845

different measuring ranges and scalings, e.g. in INCH, on inquiry



precision steel rulers

Measuring Tapes **CJL/IUB/NO**

FOR MEASURING PLANE-PARALLEL DISTANCES AND FOR INSIDE CIRCUMFERENCE AND DIAMETER OF CYLINDRICAL PARTS

SERIES 622-624



MEASURING TAPE CJL

Length measuring tape CJL for measuring plane-parallel distances
graduation distance 1 mm; with vernier 0,1 mm; laserscaled, stainless steel.
Tape width: 16 mm.

MEASURING TAPE CJL

type	measuring range distance [mm]	Code
CJL 950	60 - 950	622 00076
CJL 2200	900 - 2200	622 00077
CJL 3460	2200 - 3460	622 00078
CJL 4780	3400 - 4780	622 00079
CJL 6000	4700 - 6000	622 00080

larger measuring ranges on inquiry



length measuring tape CJL

INSIDE CIRCUMFERENCE TAPE IUB

Measuring tape for determining the inside circumference and average diameter of round, oval or constant polygonal bores. Graduation distance 1 mm with vernier 0,1 mm. Laserscaled, stainless steel;
The tape is put against the inside bore wall with the help of clamping nippers.
Tape width: 20 mm

CIRCUMFERENCE TAPE IUB

circumference range [mm]	diameter range [mm]	type	Code
clamping nippers for IUB (needed only once); for all tape ranges			623 00016
720 - 1550	230 - 490	IUB 1550	623 00012
940 - 2200	300 - 700	IUB 2200	623 00013
2190 - 3460	700 - 1100	IUB 3460	623 00014
3450 - 4720	1100 - 1500	IUB 4720	623 00015
4710 - 5980	1500 - 1900	IUB 5980	623 00071
5970 - 7230	1900 - 2300	IUB 7230	623 00086
7220 - 8500	2300 - 2700	IUB 8500	623 00087

larger measuring ranges on inquiry

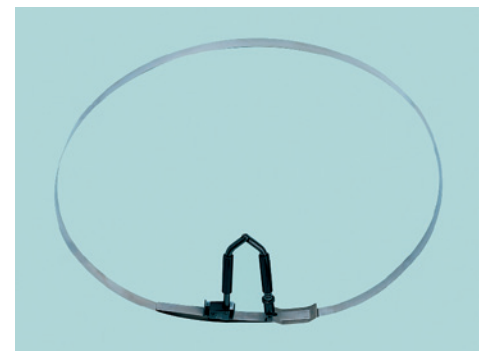

inside circumference tape IUB

NOVOMETER

Contour measuring gauge for determining the average inside diameter of round, oval or constant polygonal bores, with scaled ring and vernier.
Tape width: 20 mm

Digital Novometer: with resolution 0,01 mm; recording of measuring values through interface RS 232 or RS 485 also for SPC-Systems; digital display for \emptyset or circumference.

Novometer for outside diameter NOA: with reading 0,1 mm.

CONTOUR GAUGE NOVOMETER

diameter range [mm]	reading [mm]	Code	Code digital	NOA
14 - 24	0,1	624 00017	624 00088	-
22 - 40	0,1	624 00018	624 00089	624 00230
35 - 60	0,1	624 00019	624 00090	624 00231
55 - 100	0,1	624 00020	624 00091	624 00232
95 - 180	0,1	624 00021	624 00092	624 00233
170 - 255	0,1	624 00022	624 00211	624 00034
245 - 330	0,1	624 00070	624 00212	624 00235
spare tape for Novometer	0,1	on inquiry		
Option: sliding clutch for reproducible measuring force with elastic work pieces 35 - 330		624 00102		
Option: PTFE-coating of the tape to reduce the friction on inquiry				
Option: Table device on inquiry				



contour gauge NOVOMETER



digital NOVOMETER

OSIMESS® Precision Bore Gauge OS/OSH/OSS

FOR SMALL DIAMETERS 1,0 - 20 MM

SERIES 625-628

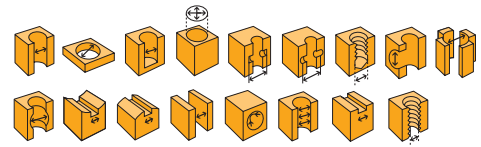

STANDARD DESIGN OS COMPLETE SETS

Delivery OS:

hardchromed design from 4,5 mm; tungsten carbide tipped for 1-4 mm, wedge-shaped measuring needle generally tungsten carbide; holder of your choice, in case, without setting rings, without dial gauge. separate probes see pages 19 and 20.

DESIGN OSH COMPLETE SETS

as described for OS, but with tungsten carbide tipped probes

DESIGN OSS COMPLETE SETS

as described for OS, but with probes for blind bores from Ø 1,75 mm



OSIMESS® - various probes

OSIMESS®		OS		OSH		OSS	
		holder without retraction	holder with retraction	holder without retraction	holder with retraction	holder without retraction	holder with retraction
application range [mm]	number of probes						
<i>nominal range</i>	<i>effective range</i>						
1,00 - 1,40	0,95 - 1,55	5	-	-	626 00200	626 00201	-
1,75 - 4,00	1,50 - 4,20	10	-	-	626 00202	626 00203	626 00003
1,00 - 4,00	0,95 - 4,20	15	-	-	626 00000	626 00001	-
4,50 - 7,50	4,15 - 7,80	7	627 00200	627 00201	627 00202	627 00203	on inquiry
8,00 - 12,00	7,70 - 12,50	6	627 00300	627 00301	627 00302	627 00303	627 00304
4,50 - 12,00	4,15 - 12,50	13	627 00000	627 00001	627 00004	627 00005	627 00003
13,00 - 20,00	12,20 - 20,60	8	628 00000	628 00001	628 00004	628 00005	628 00003

OSIMESS® Precision Bore Gauge OS

SERIES 625-628

HOLDER

Holder with retraction especially recommended for probes up to 4 mm, for blind bore probes and for the maximum protection of the probes.

HOLDER

design	Code
holder without retraction for 1,0 - 20,0 mm	625 00009
holder with retraction for 1,0 - 20,0 mm	626 00010

ACCESSORIES

	measuring range [mm]	Code
clamp with depth stop	1,0 - 4,0	626 00005
	4,5 - 9,0	627 00007
	10,0 - 20,0	628 00007
angle piece 90°	1,0 - 20,0	625 00008
measuring depth extension from Ø 10 mm	50 mm long	625 00101
	100 mm long	626 00102
	250 mm long	627 00103

OS-probe with special length for Ø < 10 mm on inquiry



angle piece 90° with OSIMESS®-holder

OSIMESS® Measuring Needles

MEASURING NEEDLES

measuring needles	Code
1,0 - 1,4 OS-OSH	626 00067
1,75 - 2,25 OS-OSH-OSS	626 00068
2,5 - 4,0 OS-OSH-OSS	626 00069
4,5 - 9 mm OS - OSH	627 00095
4,5 - 9 mm OSS	627 00096
10 - 20 mm OS - OSH	628 00055
10 - 20 mm OSS	628 00056



OSIMESS® probe
blind bore design OSS (top)
OSIMESS® probe
standard design OS (bottom)



OSIMESS® in case

setting rings set
626 00204
626 00205
626 00004
627 00205
627 00305
627 00006
628 00006

OSIMESS®-Spare Parts

PROBES 1,0 - 4,0 MM

nominal dimension [mm]	measuring range [mm]	probe OSH Code	probe OSS Code	setting ring Code
1,0	0,95 - 1,15	626 00012	-	626 00052
1,1	1,07 - 1,25	626 00013	-	626 00053
1,2	1,17 - 1,35	626 00014	-	626 00054
1,3	1,27 - 1,45	626 00015	-	626 00055
1,4	1,37 - 1,55	626 00016	-	626 00056
1,75	1,50 - 1,90	626 00017	626 00042	626 00057
2,0	1,80 - 2,20	626 00018	626 00043	626 00058
2,25	2,05 - 2,45	626 00019	626 00044	626 00059
2,5	2,30 - 2,70	626 00020	626 00045	626 00060
2,75	2,55 - 2,95	626 00021	626 00046	626 00061
3,0	2,80 - 3,20	626 00022	626 00047	626 00062
3,25	3,05 - 3,45	626 00023	626 00048	626 00063
3,5	3,30 - 3,70	626 00024	626 00049	626 00064
3,75	3,55 - 3,95	626 00025	626 00050	626 00065
4,0	3,80 - 4,20	626 00026	626 00051	626 00066

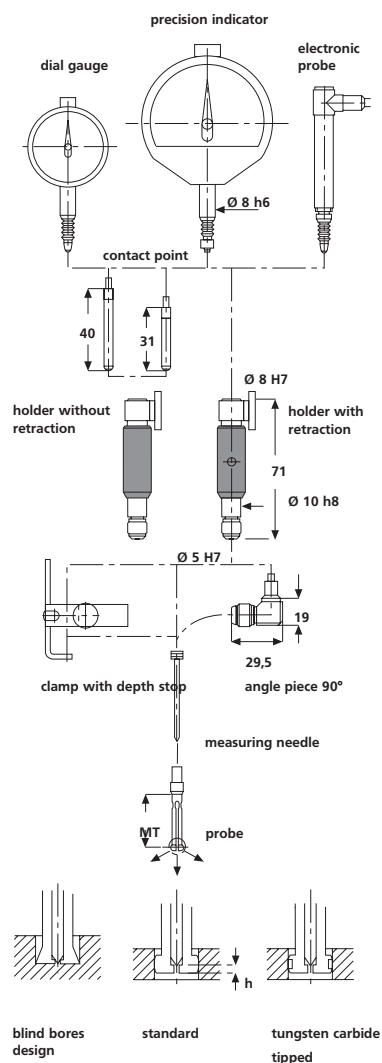

PROBES 4,5-9,0 MM

nominal dimension [mm]	measuring range [mm]	probe OS Code	probe OSH Code	probe OSS Code	setting ring Code
4,5	4,15 - 4,80	627 00015	627 00063	627 00047	627 00079
5,0	4,70 - 5,30	627 00016	627 00064	627 00048	627 00080
5,5	5,20 - 5,80	627 00017	627 00065	627 00049	627 00081
6,0	5,70 - 6,30	627 00018	627 00066	627 00050	627 00082
6,5	6,20 - 6,80	627 00019	627 00067	627 00051	627 00083
7,0	6,70 - 7,30	627 00020	627 00068	627 00052	627 00084
7,5	7,20 - 7,80	627 00021	627 00069	627 00053	627 00085
8,0	7,70 - 8,30	627 00022	627 00070	627 00054	627 00086
8,5	8,20 - 8,80	627 00023	627 00071	627 00055	627 00087
9,0	8,70 - 9,30	627 00024	627 00072	627 00056	627 00088



OSIMESS® standard probe OS

PROBES 10,0-20,0 MM

nominal dimension [mm]	measuring range [mm]	probe OS Code	probe OSH Code	probe OSS Code	setting ring Code
10	9,2 - 10,5	627 00106	627 00112	627 00109	627 00090
11	10,2 - 11,5	627 00107	627 00113	627 00110	627 00092
12	11,2 - 12,5	627 00108	627 00114	627 00111	627 00094
13	12,2 - 13,5	628 00015	628 00039	628 00031	628 00047
14	13,4 - 14,7	628 00016	628 00040	628 00032	628 00048
15	14,4 - 15,7	628 00017	628 00041	628 00033	628 00049
16	15,4 - 16,7	628 00018	628 00042	628 00034	628 00050
17	16,4 - 17,7	628 00019	628 00043	628 00035	628 00051
18	17,4 - 18,7	628 00020	628 00044	628 00036	628 00052
19	18,4 - 19,7	628 00021	628 00045	628 00037	628 00053
20	19,4 - 20,7	628 00022	628 00046	628 00038	628 00054
> 20 - 40	standard and blind bores on inquiry				

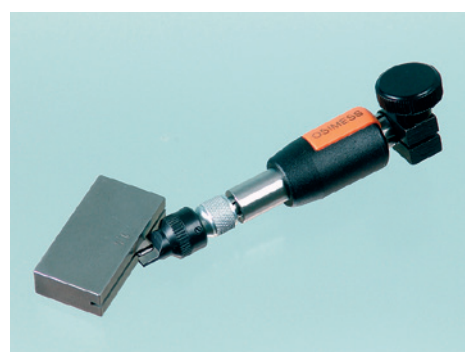

OSF special probe for keyway

SPECIAL PROBES OSF FOR MEASURING GROOVES AND RECESSES

Examples OSF:

- OSF for plane-parallel distances, e.g. keyways
- OSR convex for radial grooves, OSR concave for woodruff keys
- OSB for axial or special grooves

Please let us know the exact nominal dimension with tolerance with your order.

For OSR and OSB please indicate additionally the radius. Example:

special probe OSF No. 626 00035 3,0 H7

probe OSF No. 626 00035 3,0 + 0,15 - 0,01

OSIMESS® OSF

special probe OSF with nominal dimension [mm] between	probe Code	measuring needle Code
1,0 - 1,4	626 00027	626 00067
1,75 - 2,25	626 00032	626 00068
2,5 - 4,0	626 00035	626 00069
4,5 - 9,0	627 00031	627 00105
10,0 - 20,0	627 00042	628 00064

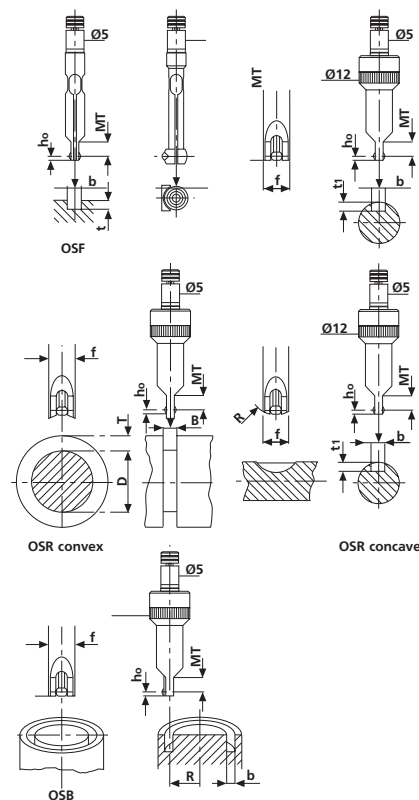

special probes OSIMESS® OSF

Measuring Stand OSM **OSM 5/OSM 6**

SERIES 629

FOR THE SERIES CONTROL OF SMALL WORKPIECES

MEASURING STAND OSM 5

Height continuously adjustable up to 250 mm, max. working stroke 90 mm. With depth measuring device and clamping device for second indicating unit. Can also be used in combination with SUBITO® or plug gauges OD or similar bore gauges as well as for depth and thickness measurements (as an option). delivery without dial gauge

MEASURING STAND OSM 5 HG HARD STONE

as OSM 5 standard, however the table is out of hard stone. High wear resistance and corrosion-resistant.

MEASURING STAND OSM 6

Height continuously adjustable up to 130 mm. Working stroke of the table max. 40 mm, suitable for workpieces up to Ø 144 mm.

MEASURING STAND

model	Code
OSM 5	629 00015
OSM 5 HG	629 00000
OSM 6	629 00016

ACCESSORIES OSM 5

designation	Code
floating workpiece support for self-alignment of small workpieces	629 00001
floating gauge block holder to ease the exact setting with gauge blocks from 1 - 20 mm	629 00002
floating holder with clamping shaft, for integrating the OSIMESS® holder or OD holder or for the use in fixtures	629 00003
measuring travel limitation for OSIMESS® holder with retraction	629 00011



measuring stand OSM 5 with OSIMESS probe



measuring stand OSM 6



floating holder

Setting Rings

ACCORDING TO DIN 2250

Ideal for setting of OD plug gauges and of SUBITO® measuring gauges. Setting rings made of hardened 62 HRC steel, according to DIN 2250. Tolerance of diameter is JS4. The rings are marked with their actual size (up to 1 µm).

SETTING RINGS

	Code
setting rings Ø 1-20 mm see series 625-628 OSIMESS	
setting rings type C Ø 1 - 300	
setting rings type B - for pneumatic plug gauges	on inquiry
setting rings for tapers	
setting rings for toothings	
setting rings more accurate than JS4	

SERIES 129

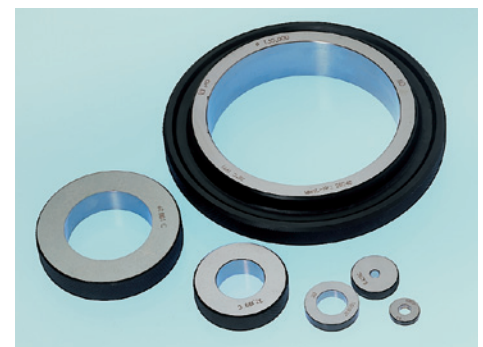

setting rings according to DIN 2250

Indicating Plug Gauge OD

FOR MEASURING INTERNAL DIAMETERS,
APPLICATION RANGE 2,0 - 800 MM

SERIES 300-326

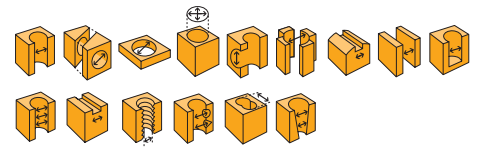

Assembly complete set:

Measuring sleeve with two radially movable contact pins, offset by 180° +
OD holder (see page 24) + indication unit of choice. Standard measuring range
s: 0,2 mm for $\varnothing \geq 6$ mm. Standard design of the measuring sleeve: hardened steel,
alternatively hard chromed, measuring contacts tungsten carbide.

Please let us know the exact bore tolerance with your order:

Example: measuring sleeve OD No. 304 00000 35 H7
measuring sleeve OD No. 304 00000 35 + 0,15/-0,01
measuring sleeve OD No. 304 00000 34,990/35,005

* nominal \varnothing 6,1 - 9 mm: h = 6 mm; nominal \varnothing 9,1 - 12 mm: h = 10 mm

OD MEASURING SLEEVES - IN HARDENED STEEL DESIGN

nominal- \varnothing [mm]	H = STANDARD					DESIGN OF THE MEASURING CONTACTS IN			
	h [mm]	carbide Code	hardchromed Code	ruby Code	diamond Code	FOR THROUGH BORES			
						h [mm]	carbide Code	hardchromed Code	
2,0 - 2,5	1	300 00015				-			
2,6 - 6,0	1,5	300 00000		300 00003		6	300 00002		
6,1 - 12,0	2,5	301 00000	301 00010	301 00003	301 00025	6/10*	301 00002	301 00026	
12,1 - 20,0	2,5	302 00000	302 00007	302 00003	302 00017	10	302 00002	302 00018	
20,1 - 30,0	3,5	303 00000	303 00007	303 00003	303 00022	10	303 00002	303 00023	
30,1 - 40,0	3,5	304 00000	304 00006	304 00003	304 00029	10	304 00002	304 00030	
40,1 - 60,0	3,5	305 00000	305 00006	305 00003	305 00020	10	305 00002	305 00021	
60,1 - 80,0	4,0	306 00000	306 00006	306 00003	306 00022	10	306 00002	306 00023	
80,1 - 100,0	4,0	307 00000	307 00006	307 00003	307 00016	10	307 00002	307 00017	
100,1 - 110,0	4,0	308 00000	308 00021	308 00022	308 00023	10	308 00002	308 00024	
110,1 - 120,0	4,0	309 00010	309 00006	309 00007	309 00008	10	309 00012	309 00009	
120,1 - 130,0	4,0	310 00010	310 00006	310 00007	310 00008	10	310 00012	310 00009	
130,1 - 140,0	4,0	311 00500	311 00503	311 00504	311 00505	10	311 00502	311 00506	
140,1 - 150,0	4,0	312 00500	312 00503	312 00504	312 00505	10	312 00502	312 00506	
150,1 - 160,0	4,0	313 00500	313 00503	313 00504	313 00505	10	313 00502	313 00506	
160,1 - 170,0	4,0	314 00500	314 00503	314 00504	314 00505	10	314 00502	314 00506	
170,1 - 180,0	4,0	315 00500	315 00503	315 00504	315 00505	10	315 00502	315 00506	
180,1 - 190,0	4,0	316 00500	316 00503	316 00504	316 00505	10	316 00502	316 00506	
190,1 - 200,0	4,0	317 00500	317 00503	317 00504	317 00505	10	317 00502	317 00506	

OD MEASURING SLEEVES - HARDCHROMED

nominal- \varnothing [mm]	H = STANDARD					DESIGN OF THE MEASURING CONTACTS IN			
	h [mm]	carbide Code	hardchromed Code	ruby Code	diamond Code	FOR THROUGH BORES			
						h [mm]	carbide Code	hardchromed Code	
2,0 - 2,5	1	300 00019	-		-	-		-	
2,6 - 6,0	1,5	300 00004		300 00034		6	300 00009		
6,1 - 12,0	2,5	301 00004	301 00032	301 00033	301 00034	6/10*	301 00009	301 00035	
12,1 - 20,0	2,5	302 00004	302 00024	302 00025	302 00026	10	302 00009	302 00027	
20,1 - 30,0	3,5	303 00004	303 00029	303 00030	303 00031	10	303 00009	303 00032	
30,1 - 40,0	3,5	304 00004	304 00036	304 00037	304 00038	10	304 00009	304 00039	
40,1 - 60,0	3,5	305 00004	305 00027	305 00028	305 00029	10	305 00010	305 00030	
60,1 - 80,0	4,0	306 00004	306 00029	306 00030	306 00031	10	306 00015	306 00032	
80,1 - 100,0	4,0	307 00004	307 00023	307 00024	307 00025	10	307 00011	307 00026	
100,1 - 110,0	4,0	308 00004	308 00030	308 00031	308 00032	10	308 00016	308 00033	
110,1 - 120,0	4,0	309 00004	309 00022	309 00023	309 00024	10	309 00016	309 00025	
120,1 - 130,0	4,0	310 00004	310 00022	310 00023	310 00024	10	310 00025	310 00026	
130,1 - 140,0	4,0	311 00512	311 00513	311 00514	311 00515	10	311 00516	311 00517	
140,1 - 150,0	4,0	312 00512	312 00513	312 00514	312 00515	10	312 00516	312 00517	
150,1 - 160,0	4,0	313 00512	313 00513	313 00514	313 00515	10	313 00516	313 00517	
160,1 - 170,0	4,0	314 00512	314 00513	314 00514	314 00515	10	314 00516	314 00517	
170,1 - 180,0	4,0	315 00512	315 00513	315 00514	315 00515	10	315 00516	315 00517	
180,1 - 190,0	4,0	316 00512	316 00513	316 00514	316 00515	10	316 00516	316 00517	
190,1 - 200,0	4,0	317 00512	317 00513	317 00514	317 00515	10	317 00516	317 00517	

SURCHARGE

design	Ø-range	Code
surcharge 3-point-design	4,0 - 8,0	319 00509
	8,1 - 40,0	319 00502
	40,1 - 60,0	319 00538
	60,1 - 100,0	319 00510
surcharge extended measuring travel 0,4 mm	2,5 - 6,0	319 00512
surcharge extended measuring travel 0,6 mm	6,1 - 20,0	319 00539
surcharge extended measuring travel 0,6 mm	> 20,1	319 00540
surcharge reduced undersize for tolerance <10 µ	2,5 - 20,0	319 00506
surcharge reduced undersize for tolerance <10 µ	> 20,1 - 100,0	319 00504
surcharge protection cover (not available for blind bore design)	> 4,0 - 20,0	319 00507
	> 20,1	319 00508

Note: These special versions are not available in every combination!
 measuring contacts hard chromed and diamond are available from Ø 8 mm;
 ruby measuring contacts from Ø 3 mm



plug gauges OD for various bore diameters

FOR BLIND BORES					
ruby Code	diamond Code	h [mm]	carbide Code	hardchromed Code	ruby Code
		0,7	300 00016		
300 00026		1	300 00001		300 00028
301 00027	301 00028	1	301 00001	301 00029	301 00030
302 00019	302 00020	1	302 00001	302 00021	302 00022
303 00024	303 00025	1,2	303 00001	303 00026	303 00027
304 00031	304 00032	1,2	304 00001	304 00033	304 00034
305 00022	305 00023	1,2	305 00001	305 00024	305 00025
306 00024	306 00025	1,2	306 00001	306 00026	306 00027
307 00018	307 00019	1,2	307 00001	307 00020	307 00021
308 00025	308 00026	1,2	308 00001	308 00027	308 00028
309 00017	309 00018	1,2	309 00011	309 00019	309 00020
310 00017	310 00018	1,2	310 00011	310 00019	310 00020
311 00507	311 00508	1,2	311 00501	311 00509	311 00510
312 00507	312 00508	1,2	312 00501	312 00509	312 00510
313 00507	313 00508	1,2	313 00501	313 00509	313 00510
314 00507	314 00508	1,2	314 00501	314 00509	314 00510
315 00507	315 00508	1,2	315 00501	315 00509	315 00510
316 00507	316 00508	1,2	316 00501	316 00509	316 00510
317 00507	317 00508	1,2	317 00501	317 00509	317 00510

FOR BLIND BORES					
ruby Code	diamond Code	h [mm]	carbide Code	hardchromed Code	ruby Code
		0,7	300 00020		
300 00032	-	1	300 00008		300 00037
301 00036	301 00037	1	301 00008	301 00038	301 00039
302 00028	302 00029	1	302 00008	302 00030	302 00013
303 00033	303 00034	1,2	303 00008	303 00035	303 00036
304 00040	304 00041	1,2	304 00008	304 00042	304 00043
305 00031	305 00032	1,2	305 00009	305 00033	305 00034
306 00033	306 00034	1,2	306 00009	306 00035	306 00037
307 00027	307 00028	1,2	307 00010	307 00029	307 00030
308 00034	308 00035	1,2	308 00005	308 00036	308 00037
309 00026	309 00027	1,2	309 00005	309 00028	309 00029
310 00027	310 00028	1,2	310 00005	310 00029	310 00030
311 00518	311 00519	1,2	311 00520	311 00521	311 00522
312 00518	312 00519	1,2	312 00520	312 00521	312 00522
313 00518	313 00519	1,2	313 00520	313 00521	313 00522
314 00518	314 00519	1,2	314 00520	314 00521	314 00522
315 00518	315 00519	1,2	315 00520	315 00521	315 00522
316 00518	316 00519	1,2	316 00520	316 00521	316 00522
317 00518	317 00519	1,2	317 00520	317 00521	317 00522

Floating contacting principle:

- H: sleeve length
- h: front distance, distance of measuring axis to bottom of the bore
- D_{max}: maximum Ø to be measured
- s: measuring range = 0,2 mm

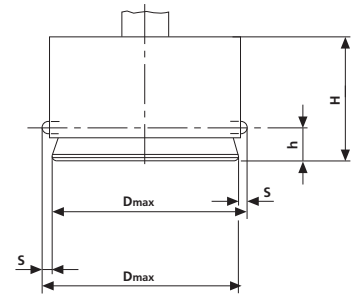

OD dimensions



OD measuring sleeve Ø 60 mm



OD measuring sleeves in special design

Indicating Plug Gauge OD

SERIES 300-326

OD CROSS SLEEVE [WITH RUNNERS]

nominal-Ø [mm]	h [mm]	cross sleeve with runners Code	h [mm]	cross sleeve with runners Code	h [mm]	cross sleeve Code
130,1 - 150	7	311 00001	18	311 00000	6	311 00002
150,1 - 200	7	312 00001	18	312 00000	6	312 00002
200,1 - 250	7	313 00001	18	313 00000	6	313 00002
250,1 - 300	7	314 00001	18	314 00000	6	314 00002
300,1 - 350	7	315 00001	18	315 00000	6	315 00002
350,1 - 400	7	316 00001	18	316 00000	6	316 00002
400,1 - 450	7	317 00001	18	317 00000	6	317 00002
450,1 - 500	7	318 00001	18	318 00000	6	318 00002

ESU setting master therefore see page 15



cross sleeve with runners from Ø 130 mm for through and deep bores

SPECIAL DESIGN ON INQUIRY

- with integrated inductive measuring probes from Ø 25 mm
- measuring contact and/or sleeve out of delrin for scratch-sensitive surfaces or polished workpieces
- front distance „h“ non standard
- measuring sleeve for automatic measuring
- multiple measuring axes
- OD measuring sleeve for parallel distances
- special profiles for extruders or for housing of toothed wheel pumps
- measuring contacts in wedge-design
- taper measurement

OD HOLDER

with thread connection M11 x 0,75 for direct connection to all OD measuring sleeves

OD HOLDER

length [mm]	Code
50	320 00000
105	320 00001
235	320 00002
greater length on inquiry	
holder F, especially for electronic length measuring probes with fine adjustment, 110 mm long	320 00004
strengthened holder with tube Ø 18 mm, recommended for sleeve Ø > 60 mm	
145	320 00038
235	320 00039
holder with retraction, 70 mm long, recommended for blind bore sleeves	320 00042

different threads on inquiry



OD holders

MEASURING DEPTH EXTENSION

for measuring also in large depth, interchangeable, therefore very flexible for different measuring depth

MEASURING DEPTH EXTENSION

length [mm]	Ø 4,0 mm for OD Ø 4,0-6,5 mm	Ø 6,5 mm for OD Ø 6,5-12 mm	Ø 12 mm for OD from Ø 12	Ø 18 mm for OD from Ø 60
50	323 00100	323 00110	323 00008	-
100	323 00101	323 00111	323 00000	323 00004
250	323 00103	323 00113	323 00001	323 00005
500	-	-	323 00002	323 00006
1000	-	-	-	323 00007

Please let us know the diameter of the corresponding OD sleeve with your order. Extensions for measuring sleeves < 4 mm: on inquiry.



OD measuring depth extensions

Accessories for Plug Gauge OD

SERIES 300-326

FLOATING HOLDER

for the use in measuring devices with automatic measuring gauge feeding

FLOATING HOLDER

	Code
for OD holder 105	629 00003
∅ 20 mm for automatic measuring	321 00000

ANGLE PIECE

	Code
90° with thread M11 x 0,75	324 00000
90° for strengthened OD holder, tube ∅ 18 mm	324 00002
90° in short design	324 00001

DEPTH STOP

for measuring in reproducible measuring depths and for eliminating the tilting error. Please indicate with your order: minimum/maximum measuring depth.

SET COLLAR [CLAMPED ON SLEEVE]

diameter measuring sleeve [mm]	Code
3,0 - 40	322 00000
40,1 - 60	322 00001

(due to the weight only up to max. ∅ 60 mm)

3-POINT DEPTH STOP [CLAMPED ON SHAFT]

diameter measuring sleeve [mm]	Code
30 - 50	322 00019
50,1 - 80	322 00020
80,1 - 100	322 00021
100,1 - 150	322 00022

BRIDGE DEPTH STOP FOR DEEP BORES [CLAMPED ON SHAFT]

diameter measuring sleeve [mm]	Code
3 - 50	322 00007
50,1 - 80	322 00008
80,1 - 100	322 00009
> 100	on inquiry

STAND

	Code
with clamping-∅ 12 mm for holder OD 105	325 00000
with clamping-∅ 18 mm for strengthened holder OD 145	325 00004



stand for OD with angle piece, plug gauge OD, depth stop, holder and precision indicator



depth stops for OD plug gauge



OD plug gauge with two measuring axes

Precision Bore Gauge **SBO/SBU**

FOR MEASURING INTERNAL AND EXTERNAL DIAMETERS, FOR BORES AROUND A HUB/WITH BORING BAR LEFT IN THE WORKPIECE, FOR CENTRING SHOULDERS, FLANGES ETC.

Manufactured individually to measure a definite bore diameter around a hub (SBO) or around a boring bar or similar (SBU);
The alignment of the gauge requires the support on the bottom of the bore or on a plane surface. High measuring accuracy. High measuring certainty. Delivery without dial gauge.

ORDER DATA **SBO/SBU**

- bore diameter with tolerance D
- diameter and height of the hub/boring bar d
- measuring depth MT
- distance of the meas. axis to the bore bottom - front distance h
- drawing of workpiece and/or workpiece
Option: special setting masters

SERIES 155

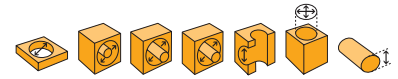

SBO precision bore gauge

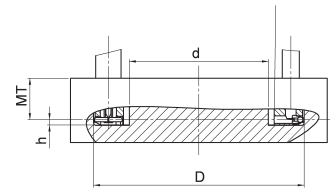

SUBITO® Precision Bore Gauge **SL**

FOR MEASURING BORES WITH BORING BAR LEFT IN THE WORKPIECE

Self-centring bore gauge for determining bore diameters, for instance with boring bar left in the workpiece.

Delivery SL: measuring gauge with column (mm- or Inch-graduation) for pre-setting of the diameter, in case, without dial gauge.

SUBITO® SL

application range [mm]	max. Ø of boring bar [mm]	measuring depth [mm]	Code
25 - 70	45	12	150 0000
35 - 105	70	17,5	151 00000
100 - 210	130	30	152 00000
100 - 280	130	30	153 00000
200 - 500	220	30	154 00000

SERIES 150-154

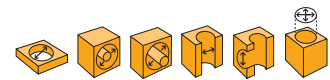

SUBITO® SL

Measuring gauge for outside diameters **SLA**

FOR FLEXIBLE MEASUREMENT OF OUTSIDE DIAMETERS.

Self-centring measurement for flexible measuring of outside diameters.

Delivery SLA: measuring gauge with scaled column to preset the diameter, in case, without dial gauge

SLA

application range [mm]	Code
20 - 45	150 00500
35 - 70	151 00500
60 - 130	152 00500
120 - 220	153 00500

SERIES 150-154



SUBITO® SLA

Ring Gauge for outside diameter **MRD**

TO MEASURE OUTSIDE DIAMETERS IN THE RANGE
20 - 80 MM

Self-centring measuring gauge to measure the outside diameter 20-80 mm. Individually designed for the diameter to be measured through a guiding sleeve. Floating contacting = two moveable measuring contacts. For setting a cylindrical plug gauge is required. Delivery without dial gauge and without cylindrical plug gauge. On inquiry

SERIES 155



MRD Ring Gauge

SUBITO® SD with direct measuring axis **SD**

FOR MEASURING LARGE BORE DIAMETERS
FROM 280 MM

The display of the bore diameter is made by a mechanical or electronic dial gauge which is integrated directly in the measuring gauge. The measuring travel depends on the dial gauge used. With SUBITO® centring and SUBITO® measuring pins. Delivery without dial gauge.

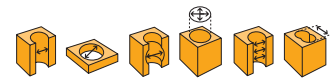

SUBITO® SD

application range [mm]	measuring pin steel Code	measuring pin carbide Code
SD 280 - 510	113 00500	113 00502
SD 400 - 800	114 00500	114 00502

Option from diameter 400 mm: when using bar gauge block extensions instead of standard measuring range extensions it is possible to measure different diameters with just one setting reference.



SUBITO® SD

Measuring Gauge for internal threads

FOR MEASURING THE PITCH DIAMETER

Based on proven SCHWENK internal measuring gauges. Application range: 8-200 mm. Thread measuring insert included. Delivery without gauge holder OSIMESS® or ON, without thread setting master and without dial gauge. For calibration a corresponding thread setting master is necessary.

MEASURING GAUGE FOR INTERNAL THREADS

type	application range [mm]	Code
measuring gauge for internal threads OSG	M8 - M10	627 00500
OS holder with retraction		626 00010
measuring gauge for internal threads ONG	M10 - M70	195 00999
ON holder for split probe		190 00000
measuring gauge for internal threads SNG	M80 - M130	166 00500
no separate gauge holder necessary	M130 - M200	166 00503



OSG measuring gauge for internal threads



SNG measuring gauge for internal threads

Internal Chamfer Gauge IFM **IFM**

FOR DIRECT MEASURING THE MAJOR DIAMETER OF INTERNAL CHAMFERS AND TAPERS

Delivery with a special ratio dial gauge (reading 0,01 mm) for indication of measuring result. Holder with 90° or 127° taper. The gauge is preset.

INTERNAL CHAMFER GAUGE IFM

type	measuring range [mm]	Code
IFM 20/90°	0,5 - 20	194 00000
IFM 40/90°	20 - 40	194 00001
IFM 20/127°	0,5 - 20	194 00011
IFM 40/127°	20 - 40	194 00012

taper 60° on inquiry

SPARE PARTS IFM

type	Code IFM 20	Code IFM 40
special dial gauge for 90°	194 10006	194 10016
holder with 90° taper	194 00003	194 00004
special dial gauge for 127°	194 10017	194 10017
holder with 127° taper	194 00005	194 00006

taper 60° on inquiry

SERIES 194



IFM Internal Chamfer Gauge

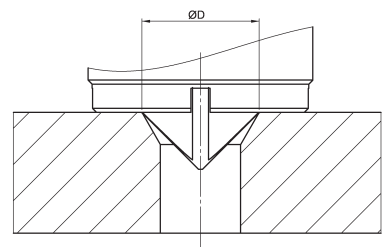

measuring principle IFM

Chamfer Length Measuring Gauge FLM **FLM**

TO MEASURE THE OUTSIDE OR INSIDE CHAMFER LENGTH

Smallest bore \varnothing 6 mm, min. chamfer length 0,2 mm, max. chamfer length 5 mm, chamfer angle $\geq 30^\circ$. Delivery including setting piece as sharp edge ring and dial gauge.

CHAMFER LENGTH MEASURING GAUGE FLM

type	Code
chamfer length measuring gauge FLM	194 00100

SPARE PARTS FLM

type	Code
depth gauge	194 00102
setting piece	194 00103



FLM Chamfer Length Measuring Gauge

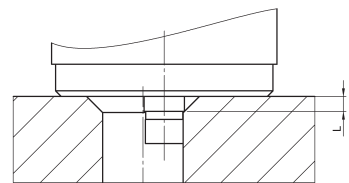

measuring principle FLM

Precision Indicator mytast®

FOR PRECISION BORE GAUGES OF ALL SERIES

Precision indicator according to DIN 879, ball bearing guided tracer rod, shock-proof, 7 jewel movement, measuring force 1 N, adjustable tolerance markings, clamping shaft \varnothing 8 h6, with contact point 16 mm, delivery in plastic box.

MYTAST*/CENTITAST

type	reading	range [mm]	Code [mm]	model
mytast*	0,001	0,1	610 00000	standard
centitast	0,01	0,5	611 00000	standard

deviating measuring force and contact points on inquiry

Mechanical Dial Gauges

FOR PRECISION BORE GAUGES OF ALL SERIES

Design according to DIN 878, clamping \varnothing 8 h6, delivery in plastic box.

DIAL GAUGE

reading [mm]	housing \varnothing [mm]	range [mm]	Code
0,01	58	10,0	600 00000
0,01	40	3,0	600 00001
0,001	58	1,0	600 00002
0,001	40	1,0	600 00003

Digital Dial Gauges

FOR PRECISION BORE GAUGES OF ALL SERIES

Features:

- high-contrast LCD digital display
- operating and display unit turnable 280° (except for 1075 R)
- lifter protection cap on the measuring pin end
- clamping shaft and measuring pin out of hardened stainless steel
- immediate readiness through reference system
- data exit MarConnect (with optical data cable for USB, RS232C or Digimatic)

DIGITAL DIAL GAUGES

type	measuring range [mm/inch]	resolution [mm]	Code
1075 R	12,5 / 0,5	0,01	613 00000
1086 R	12,5 / 0,5	0,01	613 00014
1086 R	12,5 / 0,5	0,01/0,004/0,001/0,0005	613 00011
1087 BR	12,5 / 0,5	0,01/0,004/0,001/0,0005	613 00012

1086 R: with adjustable factor e.g. for IFM.

1087 BR: the reversal point can be determined automatically when measuring with a two point internal comparator measuring instrument (SUBITO®, OSIMESS®) when tipping the gauge. The actual value is stored through the MIN-function and shown on the display.

SERIES 610-611



mytast®



centitast

SERIES 600



dial gauges, housing \varnothing 58 mm and 40 mm

SERIES 613



1087 BR

mytast® is a registered brand name of SCHWENK Beteiligungs-GmbH & Co. KG.

Manufacturer certificate for all SCHWENK measuring gauges see page 32

Tungsten carbide precision balls

SERIES 680

EXTREMELY WEAR-RESISTING AND
NON-CORRODING

Applications:

measuring gauges, calibration tools, high-pressure valves, colour squirt devices,
ball point pens, aerospace

Material: sintered metal 94% WC and 6% Co

Hardness: HV 1550 ±50

Precision: Grade 25

TUNGSTEN CARBIDE BALLS

diameter		Code	diameter		Code
[mm]	[inch]		[mm]	[inch]	
0,793750	1/32	680 00008	10,50		680 00047
1,00		680 00011	11,00		680 00048
1,190625	3/64	680 00012	11,50		680 00050
1,50		680 00015	12,00		680 00052
1,58750	1/16	680 00016	12,69988	1/2	680 00054
2,00		680 00018	13,00		680 00055
2,381250	3/32	680 00019	13,493750	17/32	680 00056
2,50		680 00020	14,00		680 00058
2,778125	7/64	680 00021	14,2875	9/16	680 00059
3,00		680 00022	14,50		680 00060
3,1750	1/8	680 00023	15,081250	19/32	680 00062
3,50		680 00024	15,8750	5/8	680 00064
3,968750	5/32	680 00025	16,00		680 00065
4,00		680 00026	16,668750	21/32	680 00066
4,50		680 00027	17,00		680 00067
4,76250	3/16	680 00028	17,46250	11/16	680 00068
5,00		680 00029	18,00		680 00069
5,50		680 00030	19,00		680 00071
5,556250	7/32	680 00031	19,050	3/4	680 00072
6,00		680 00032	19,843750	25/32	680 00073
6,350	1/4	680 00033	20,00		680 00074
6,50		680 00034	20,6375	13/16	680 00075
7,00		680 00035	21,00		680 00076
7,143750	9/32	680 00036	21,431250	27/32	680 00077
7,50		680 00037	22,00		680 00078
7,93750	5/16	680 00038	22,2250	7/8	680 00079
8,00		680 00039	23,00		680 00080
8,50		680 00040	23,81250	15/16	680 00081
8,731250	11/32	680 00041	24,00		680 00082
9,00		680 00042	24,606250	31/32	680 00083
9,50		680 00043	25,00		680 00084
9,5250	3/8	680 00044	25,40	1	680 00085
10,00		680 00045	26,00		680 00086

further dimensions on inquiry



tungsten carbide precision balls

Ruby precision balls

SERIES 680

RESISTANT TO HIGH TEMPERATURES,
WITH VERY LOW WEIGHT, ACID-RESISTING AND
GOOD SLIDING QUALITY

Applications:

measuring gauges, contact balls for dial gauges, aerospace, chemical and
nuclear industry

Material: aluminium-oxide

Hardness: Knoop 2000

Precision: Grade 25

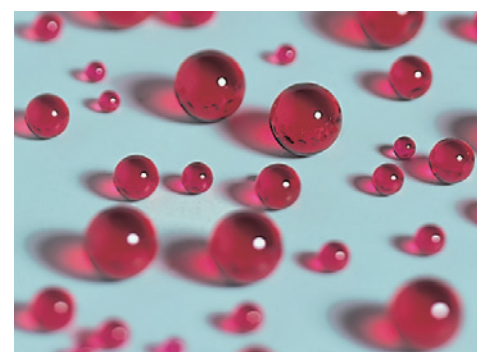

ruby precision balls

Ceramic precision balls

RESISTANT TO HIGH TEMPERATURES,
INSENSITIVE TO ABRASION AND
AGGRESSIVE MEDIA

Applications:

measuring gauges, valves, flowmeters, chemical and nuclear industry

Material: aluminium-oxide

Hardness: Knoop 2000

Precision: Grade 25

SERIES 680



ceramic precision balls

Special measuring inserts

ACCORDING TO CUSTOMER CONFIGURATION

for:

- dial gauges, precision indicators
- electronic probes
- measuring machines
- measuring devices
- manufactured according to specifications

SERIES 681



special measuring inserts

Linear stroke ball bearing

FOR EASY BLACKLASH-FREE LINEAR MOVEMENTS

LINEAR STROKE BALL BEARING

designation	Code
ball bearing traveller with clamping shaft	
Ø 8 h6, with contact point 6 mm and 16 mm, with bellows, travel h = 3 mm	614 00000

SERIES 614



linear stroke ball bearing

Measuring instrument test device **MPV**

FOR CHECKING ONE-AXIAL
LENGTH MEASURING GAUGES

TEST DEVICE MPV

	Code
measuring instrument test device MPV, for checking	
- internal 2-point-contact comparator gauges (for instance SUBITO®, OD, OSIMESS® etc.)	
- dial gauges	650 00000
- precision indicators	
for deviation, repeatability, hysteresis	

Delivery MPV:

- main stand, two setting units with integrated micrometer screws
- angle piece with clamping lug, adjustable anvil
- adapter for various measuring sleeves connection threads

Options on inquiry:

- reference sensor
- hardware for the data logging for TastkalWin
- data logging software TastkalWin
- drive units for the automatical checking run of 2-point internal measuring gauges

SERIES 650

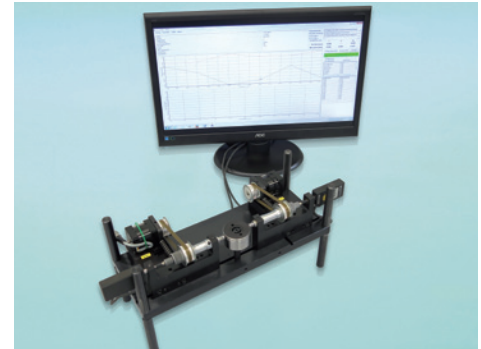

MPV complete system

Manufacturer calibration report

FOR SCHWENK MEASURING GAUGES

MANUFACTURER CALIBRATION REPORT FOR MEASURING GAUGES

Scope of testing:

checking of repeatability, deviation, hysteresis and total deviation (for comparator measuring gauges without dial gauge clamped in) at several measuring points, as well as visual and functional checking.

MEASURING GAUGES

description	Code
SUBITO® precision bore measuring gauges series SU, SK, SV, SS, SP, KT and SCA up to SU 50-150 included	699 00176
SUBITO® precision bore measuring gauges series SU, SK, SV, SS, SP, KT and SCA, from SU 100-160 as well as SMT, SW, SE, SN, ST, SL	699 00193
OSIMESS® split-ball probe OS, OSH, OSS up to probe 4,0 included	699 00194
OSIMESS® split-ball probe OS, OSH, OSS from probe 4,5	699 00178
precision indicator mytast®/centitast according to DIN 879 part 1	699 00179
dial gauge with 10 mm travel according to DIN 878	699 00185
OD plug gauges up to Ø 200 mm	699 00180
groove measuring gauge ON/ONM	699 00181
internal chamfer gauge IFM	699 00204
precision bore gauge SBO up to Ø 200 mm	699 00203

SERIES 699

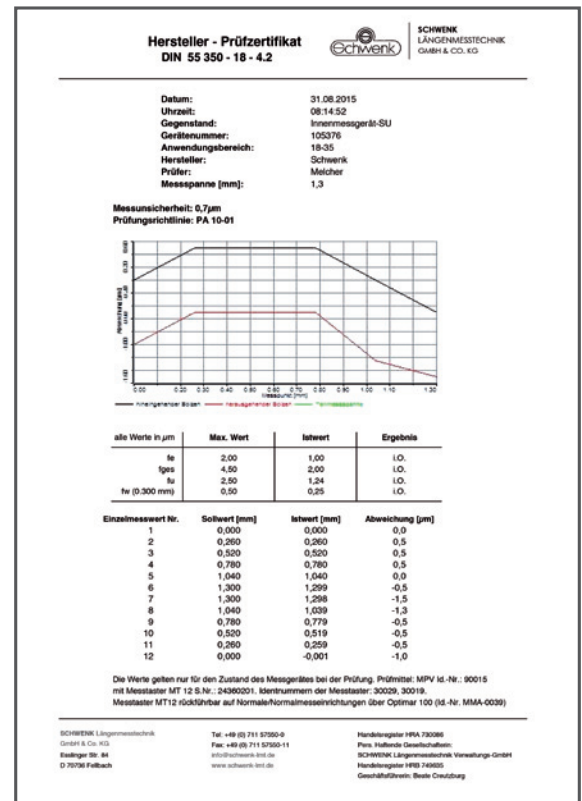

manufacturer calibration report

Manufacturer calibration report

SERIES 699

FOR SCHWENK MEASURING GAUGES

SETTING RINGS

description	Code
setting rings according to DIN 2250 and OSIMESS® setting rings according to works standard, checking in 1 level; for Ø 0,5 - 1,4 mm	699 00195
setting rings according to DIN 2250 and OSIMESS® setting rings according to works standard, checking in 3 levels; from Ø 1,75 mm	699 00209

MEASURING ANVILS ESU

description	Code
pair of measuring anvils for setting device ESU, checking for evenness deviation and the mean surface roughness	699 00187

MEASURING TAPES

description		Code
outside circumference measuring tape C-tape CJU 950 and CJU 2200 and CJL up to 2200	checking of 1 scale (Ø or circumference) at several measuring points	699 00188
outside circumference measuring tape CJU 950 and CJU 2200	checking of both scales at several measuring points	699 00189
inside and outside circumference measuring tape from CJU 3460 up to CJU 11.010 and IUB and CJL from 3500	checking of 1 scale (Ø or circumference) at several measuring points	699 00183
inside and outside circumference measuring tape from CJU 3460 up to CJU 11.010 and IUB	checking of both scales at several measuring points	699 00184
contour measuring gauge NOVOMETER	checking of the diameter at several measuring points	699 00186

SCALES

description	Code
checking scales, work scales like e.g. rulers, steel scales, tape measures, for lengths up to 1.200 mm	699 00196
checking scales, work scales like e.g. rulers, steel scales, tape measures, for lengths from 1.200 mm up to 2.000 mm	699 00197

For all calibration tasks, the traceability to the national standards is ensured. This is shown in each certificate.

General Terms and Condition of Sale and Delivery

OF SCHWENK LÄNGENMESSTECHNIK GMBH & CO. KG
(HEREINAFTER REFERRED TO AS "SCHWENK LMT")

A. General information, scope

- (1) Our General Terms and Conditions of Sale and Delivery (hereinafter referred to as "General Terms and Conditions") apply exclusively. Any opposing, supplementary or deviating client's conditions will not be accepted, unless explicitly agreed to in writing. Our General Terms and Conditions shall also apply in case we render deliveries and services to the customer without reservations and with the knowledge of any conditions of the customer that contradict or deviate from our conditions. These conditions shall also apply for future business transactions even if these have not once again been explicitly agreed upon.
- (2) Any rights to which SCHWENK LMT is entitled to under statutory provisions or other agreements that go beyond these General Terms and Conditions shall remain unaffected.
- (3) Our General Terms and Conditions shall only apply towards organizations in the sense of double sections §§ 14, 310 I BGB (German Civil Code) or legal persons of public law.

B. Quotes and offers, acceptance, contractual content

- (1) Unless explicitly stated otherwise our offers are always non-binding. Our written order confirmation is relevant for the contractual agreement. Subsidiary agreements and changes shall always be confirmed by us in writing.
- (2) We reserve all proprietary and intellectual property rights as well as copyrights to any and all tender documents (including any samples, illustrations, drawings, product descriptions provided, etc.). Such documents must not be made available to third parties or be used for purposes that go beyond the scope of the contract.
- (3) We reserve the right to implement design changes, improvements as well as other changes to technical data and performance features to an extent reasonably acceptable to the customer.
- (4) Any documents provided to the customer together with the quotation request or the order (drawings, samples and such) form a binding basis for preparing a quote.

C. Prices, payment, maturity

- (1) All prices are net prices, unless (in individual cases) otherwise agreed upon in writing and the prices are stated in euro, ex works, excluding packaging expenditures, insurance, taxes, transport costs, duties, etc. plus statutory VAT applicable at the time of delivery. The prices will be calculated on the basis of the respective price list applicable on the order date.
- (2) For small orders we charge a minimum quantity surcharge based on the current price list valid at the order time.
- (3) Unless otherwise agreed the following payment conditions shall apply:
 - payment within 10 days from date of invoice: 2 % discount,
 - payment within 30 days net from date of invoice.This shall also apply to partial deliveries. Repair invoices shall immediately become due and payable without a discount. Payment by the customer shall not be deemed to have been made until the amount is credited on our account. In case of payment by check, payment is considered rendered once the check has been cashed in.
- (4) The retention of payments or the set-off because of any counter-claims shall only be admissible in case of uncontested, acknowledged or legally recognized counter-claims of the customer.

D. Delivery dates, impossibility of delivery, partial delivery, delay in acceptance

- (1) The delivery dates shall only be binding if explicitly confirmed by us in writing. The delivery time shall commence on the date of order confirmation.
However, this shall only apply in case all technically and otherwise contractually relevant details have been clarified with the ordering party (such as a down payment, material supply etc.) and the ordering party has completely fulfilled the required obligations to cooperate in time. If this is not the case the delivery time shall be extended accordingly, unless SCHWENK LMT is responsible for the delay.
- (2) We reserve the right to object to unfulfilled contracts.
- (3) The delivery time shall be deemed to have been met if the object of delivery has left SCHWENK LMT's works in Fellbach by the expiry of the delivery period or the readiness for dispatch has been communicated.
- (4) In case shipment or acceptance of the object is delayed for reasons within the customer's responsibility, the customer shall bear the costs incurred due to the delay as of one month after notice of readiness for delivery and/or acceptance has been given.
- (5) In case the delivery time is delayed due to force majeure, strike or other events beyond the scope of influence of SCHWENK LMT, the delivery period shall be extended accordingly. SCHWENK LMT shall inform the ordering party on the beginning and end of such circumstances as soon as possible.
- (6) The ordering party can withdraw from the contract without setting a grace period if SCHWENK LMT is definitely unable to fulfill all his obligations under this contract before the transfer of risk.
Furthermore, the ordering party can withdraw from the contract if the execution of a part of the delivery becomes impossible or in case the ordering party has a legitimate interest in rejecting partial delivery. If this is not the case the ordering party shall pay the contractually agreed price for the partial delivery. The same shall apply in case of impossibility of performance of SCHWENK LMT. Apart from that H and M shall apply.
- (7) In case of a delay in acceptance caused by the customer or in case he culpably infringes his / her obligation to cooperate, SCHWENK LMT shall be entitled to claim for damages, including additional expenditure. The right to assert further claims or rights shall remain unaffected.
- (8) In case the prerequisites of paragraph (4) shall apply, the risk of accidental loss or deterioration of the purchase object shall be transferred to the customer at the time when the latter has got into arrears of acceptance or payment of debts.
- (9) Partial deliveries are admissible if the deliveries can be divided and are (reasonably) acceptable to the ordering party. SCHWENK LMT is entitled to claim partial payments and down payments in this respect.
- (10) The deliveries and services (performance of the contract) are subject to the proviso that there are no obstacles to performance based on national or international regulations, in particular export control regulations, embargoes or other sanctions. The contracting parties undertake to provide all information and documents required for the export/transfer /import. Delays due to export inspections or approval procedures shall invalidate deadlines and delivery times. If necessary permits are not granted, the contract shall be deemed not to have been concluded with regard to the parts concerned; claims for damages shall be excluded to this extent and due to the above-mentioned failure to meet deadlines.

E. Transfer of risks

- (1) The risk of accidental loss or accidental deterioration shall be transferred to the ordering party once the delivery object has been handed over to the transport company (also in case partial deliveries are made or in case SCHWENK LMT has also taken over other items, e. g. transport costs or delivery and installation).
- (2) In case delivery and acceptance are delayed or not possible due to circumstances beyond SCHWENK LMT's responsibility, the risk shall be transferred to the ordering party as of the time of receipt of the notification on the readiness for shipment. On explicit and written request and on expense of the customer, insurance can be concluded for the goods.

F. Packing

Unless individually agreed on in the contract, packing shall be charged at cost price. On request, the packaging material will be taken back on delivery.

G. Reservation of title

- (1) All the goods delivered shall remain our property until complete fulfillment of all existing or future claims arising out of the business relationship with the customer.
If the customer acts in a way contrary to the contractual obligations, in particular in case of default of payment we are entitled to take back the delivered goods. In case insolvency proceedings are opened against the customer, SCHWENK LMT is entitled to withdraw from the contract and demand the immediate return of the object of delivery.
SCHWENK LMT's taking back of the goods delivered shall not constitute a withdrawal from the contract. After taking back the goods SCHWENK LMT is entitled to dispose of them; the revenue from such utilization must be set off against the customer's liabilities minus any reasonable costs of utilization.
- (2) In the event of seizures or other action by third parties, the customer shall notify us immediately in writing so we can file a lawsuit in accordance with sec. 771 German Code of Civil Procedure (ZPO). Unless the third party is able to refund the

court and out-of-court costs incurred by us in accordance with sec. 771 German Code of Civil Procedure (ZPO), the customer shall be liable for any losses incurred by us.

- (3) The customer is entitled, subject to revocation, to the intended further sale of the delivered goods in the framework of the ordinary course of business. Already now, the customer transfers all claims to the amount of the final invoice amount (including VAT) of our claim, which arises from reselling the goods to his customers or third parties. We hereby accept the assignment. The assigned claims serve to secure all claims in accordance with paragraph 1. On our request the customer is obliged to immediately disclose the assignment to his customers and to provide the information and documents necessary to assert our rights.
- (4) For the time of the reservation of title the goods shall be treated with due care and the customer shall sufficiently insure the goods, at the original value and at his expense, against fire, water and theft.
- (5) On the ordering party's request, SCHWENK LMT is obliged to release the securities to which the ordering party is entitled to if the realizable value of the security, taking into account the downward valuation adjustment, which is customarily used by banks, exceeds the receivables arising from the business transaction with the customer to secure by more than 15%. As regards the evaluation, the invoiced value of the products subject to retention of title and, the nominal value of receivables shall be authoritative. The selection of the items to be released in detail lies at the discretion of SCHWENK LMT.

H. Warranty

- (1) SCHWENK LMT shall assume warranty that the delivered goods are suitable for the use designated in the contract and that they are free of defects.
- (2) The goods shall be checked and verified on receipt. Any obvious defects of the goods shall be immediately, and at the latest within two weeks as of receipt of the goods, contested in writing. Hidden defects must be reported within 2 weeks after discovery of the defect. Otherwise, the goods are regarded as complete and delivered without faults.
- (3) In case the goods are defective SCHWENK LMT may choose, at its own discretion, repair or replacement. For the repair option, the defective parts shall be sent to SCHWENK LMT's headquarters. Repair works will not be implemented at the place of use. If SCHWENK LMT fails to provide repair or replacement, the ordering party is entitled to reduce the purchase price accordingly or to withdraw from the contract. In order to carry out all subsequent improvements and replacement deliveries deemed necessary to SCHWENK LMT in our fair judgment the ordering party shall grant SCHWENK LMT the necessary time and opportunity.
- (4) The ordering party's right to assert claims on grounds of default is subject to the statute of limitations after 1 year from the time of transfer of risks.
- (5) No warranty is given for damage resulting from any of the following causes: improper or inappropriate use or storage, defective installation or commissioning by the ordering party or a third person, normal wear and tear, dirt, incorrect or negligent handling, in particular excessive usage, improper operating and cleaning agents, substitute materials, chemical, electrochemical or electrical influences unless the damage can be attributed to SCHWENK LMT. The same applies if the labeling by the manufacturer (serial or article number, model name etc.) has been removed or made illegible.
- (6) SCHWENK LMT shall not be liable for damages, which are the result of the design prescribed by the ordering party or the material supplied by the ordering party.

I. Return of goods, conditions of return, delivery

- (1) In principle, properly ordered and delivered goods shall not be taken back. Following different, previous agreements, the return shipment shall be made by the customer free of charge. The goods must be properly packed and transported. Any costs for rework necessary due to an infringement of this obligation shall be borne by the ordering party.
- (2) For return consignments for which SCHWENK LMT does not account (e.g. erroneous order), we charge administrative costs to the amount of 20 % of the value of the goods and a minimum of 20 Euro.
- (3) If a cost estimate is requested for repairs sent to us, the checking and handling charges for preparing the cost estimate will be charged at a flatrate of 17 Euro. In case of an order (repair or new gauge) no flatrate is applicable.

J. Samples

Samples will be charged.

K. Tool costs

Unless other agreements have been made, the tools, moulds and devices made for executing the order shall remain our property. This also applies in case the costs have been invoiced (in part or total) to the customer.

L. Custom-made products

Custom-made products require binding information on design, quantity, etc. in written form when placing an order. Changes or deletions are possible no later than one week after the confirmation date. Thereafter, changes or deletions are only possible against payment of the costs incurred. Custom-made products cannot be returned.

M. Liability, exclusion of liability

- (1) We are liable in accordance with the statutory provisions insofar as the customer asserts claims for damages caused by intent or gross negligence, including intent or gross negligence of our representatives or agents. Insofar as we cannot be charged with intentional or grossly negligent breach of contract the liability for damages is limited to a predictable damage that might typically occur.
- (2) If the delivered object cannot be used by the ordering party for the purposes agreed upon in the contract due to the fault of SCHWENK LMT, the provisions according to M, N are to be applied, to the exclusion of further claims by the customer.
- (3) We do not assume warranty for damages caused by erroneous use of the goods, in particular inappropriate or improper use or storage, incorrect assembly by the client or third parties, unauthorized repair attempts and changes, normal wear and tear, erroneous or negligent treatment etc. beyond our influence and control and in case of unintended use or ignorance of our manuals.
- (4) SCHWENK LMT makes no warranties, in particular no guarantees regarding quality or durability, unless otherwise agreed in writing.
- (5) The limitation period in case of delivery regress is based on the statutory provisions.
- (6) Any additional claim for compensation other than the aforementioned in "M" is, regardless of the legal nature of the asserted claim, excluded.
- (7) Unless otherwise specified or unless mandatory statutory regulations stipulate something else, our liability is excluded. The aforementioned limitation of liability shall not apply to claims for damages of the ordering party in case of injury to life, body or health and for mandatory claims according to the product liability or medicine act (e.g. double sections 1.4 German ProdukthaftG, etc.).
- (8) As far as the liability for compensation against us is excluded or restricted, this shall be applicable as well with respect to the personal liability for compensations of our employees, staff members, representatives and vicarious agents.

N. Data protection

We expressly point out to our business partners that we store and process personal data by use of electronic data processing tools in accordance with the regulations of the Federal Data Protection Act and the Data Protection Basic Regulation.

O. Jurisdiction, German law, contract language, severability clause

- (1) Our business headquarters is the place of performance (to the extent that the customer is a merchant) and also the place of jurisdiction. We are, however, authorized to sue the customer at the court of his place of residence.
- (2) The law of the Federal Republic of Germany shall apply. The terms of the UN Sales Convention shall not apply. The contract language is German.
- (3) Should one of the terms of the General Terms and Conditions become invalid or be or become impracticable, the validity of the remaining sections is not affected.